



Mopar

PARTS

Jeep Grand Cherokee WJ Sirius Satellite Radio Installation

DAIMLERCHRYSLER

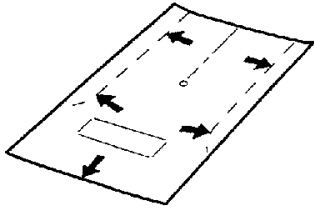

A Antenna mount template

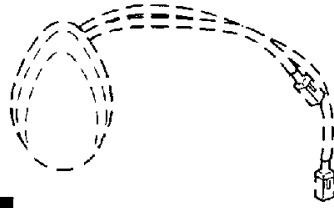

B Roof mount antenna

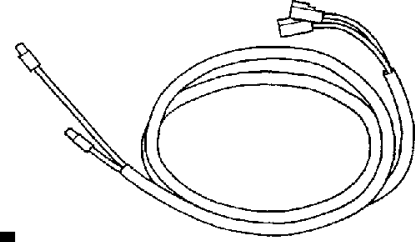

C Antenna to multiplex splitter cable



D 2x

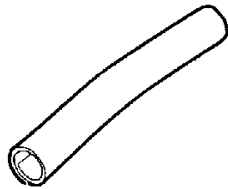

E

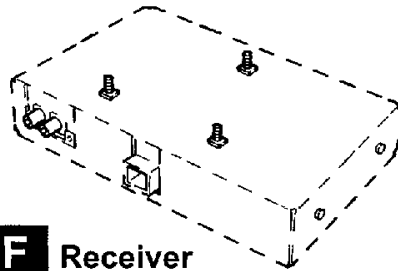

F Receiver



G 3x



H 5x



I 7x

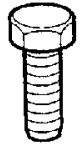

J 7x

KIT CONTENTS SPECIFIC TO VEHICLES EQUIPPED WITH CD CHANGER:

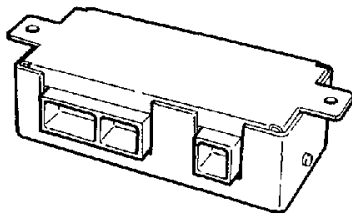

K Multiplex splitter

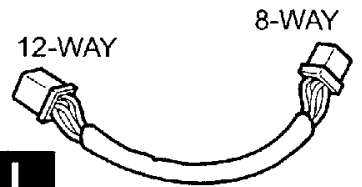

L

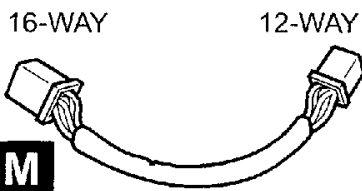

M

KIT CONTENTS SPECIFIC TO VEHICLES WITHOUT CD CHANGER:

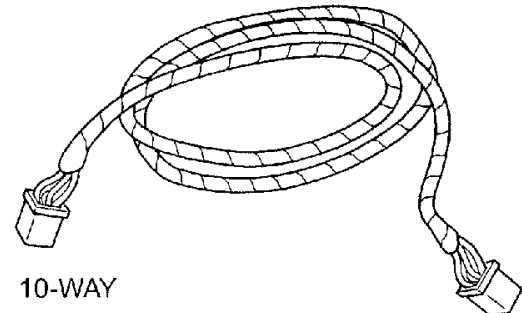

N

NOTE: There may be some miscellaneous hardware or items left over after completing this installation. Please use only the items and quantities shown in the parts list above.

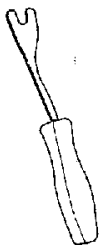

SCRAP CARDBOARD

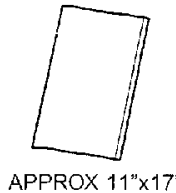

APPROX 11"x17"

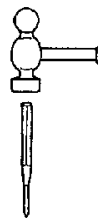
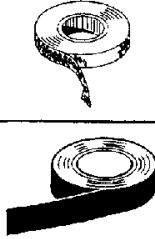

1/8" (3.2mm)
13/64" (5mm)
3/4" (19mm)
05086662AA

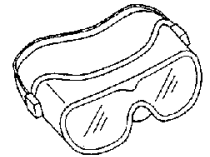
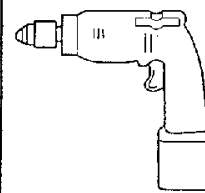

82300508

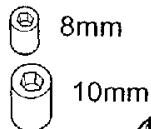

8mm

10mm

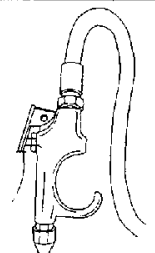
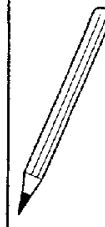
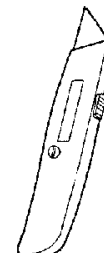
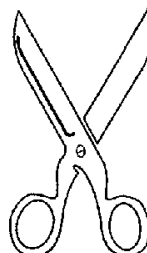
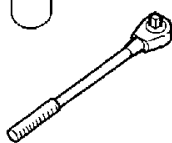

Note: For vehicles WITH CD changer follow steps 1-31
For vehicles WITHOUT CD changer follow steps 1-20 and 21-42

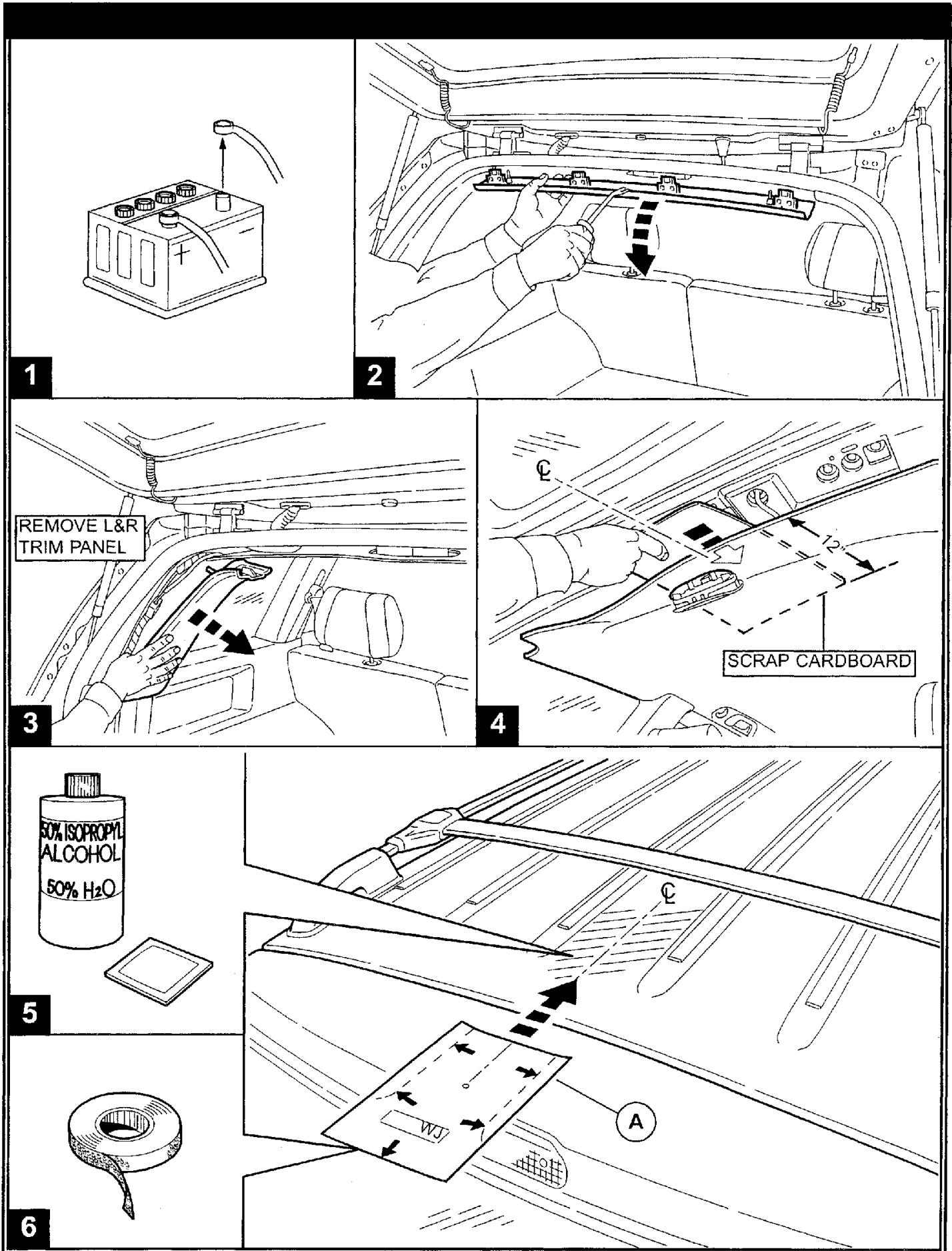

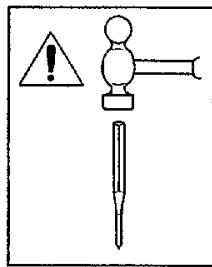

7

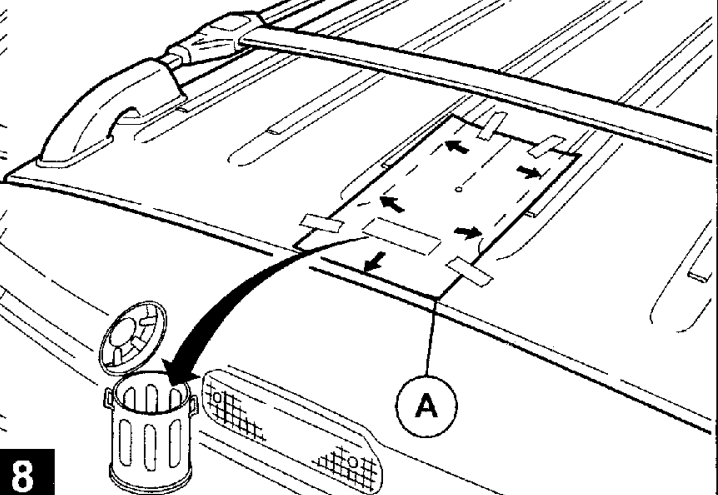
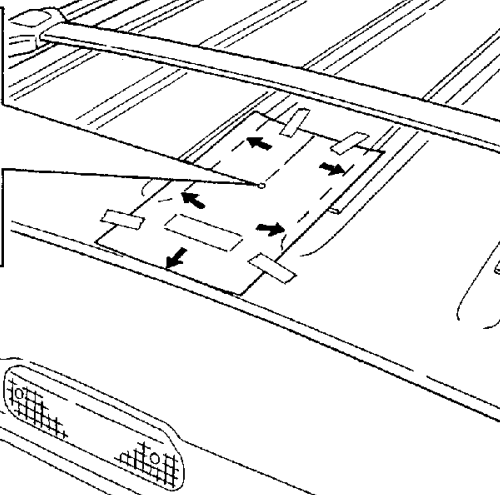

8

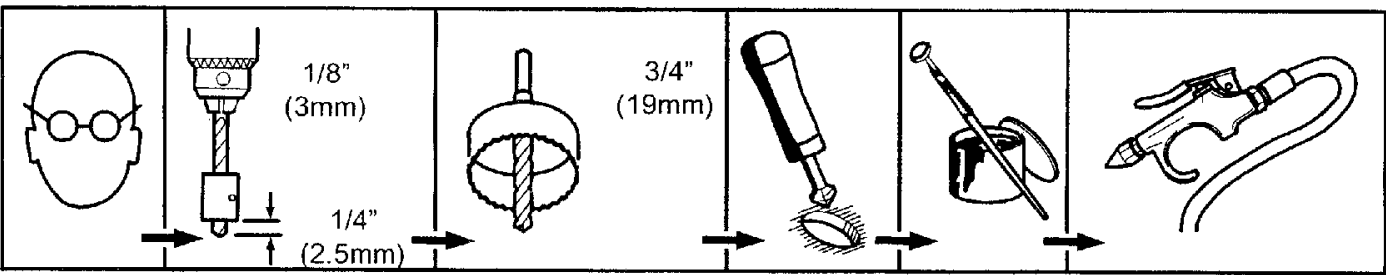

9

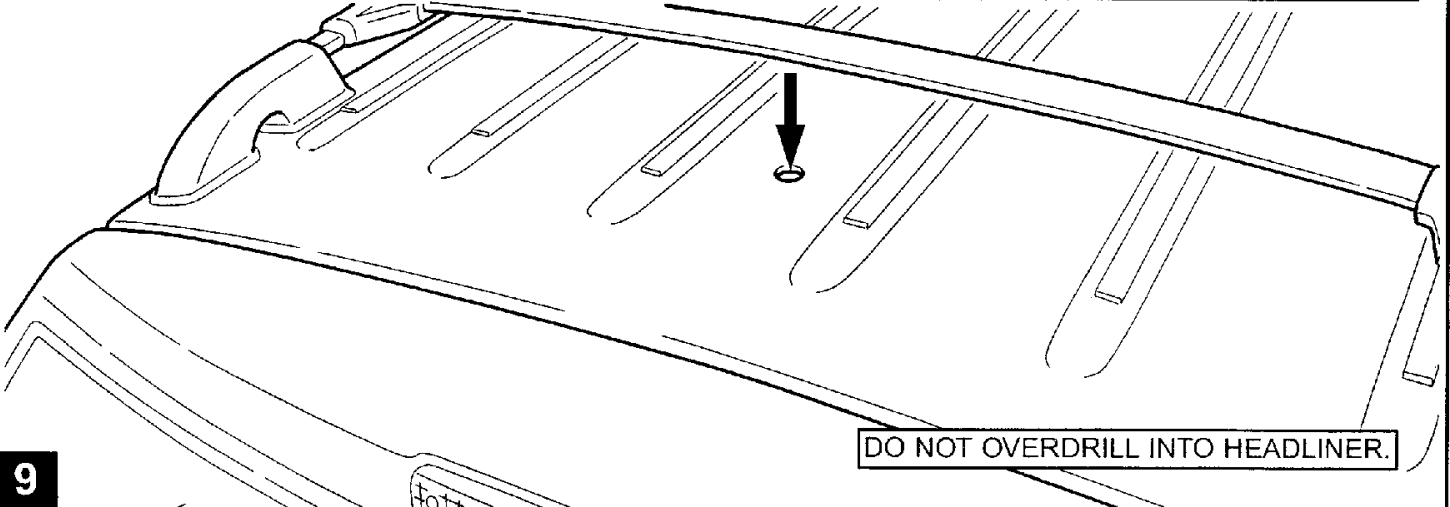

DO NOT OVERDRILL INTO HEADLINER.

10

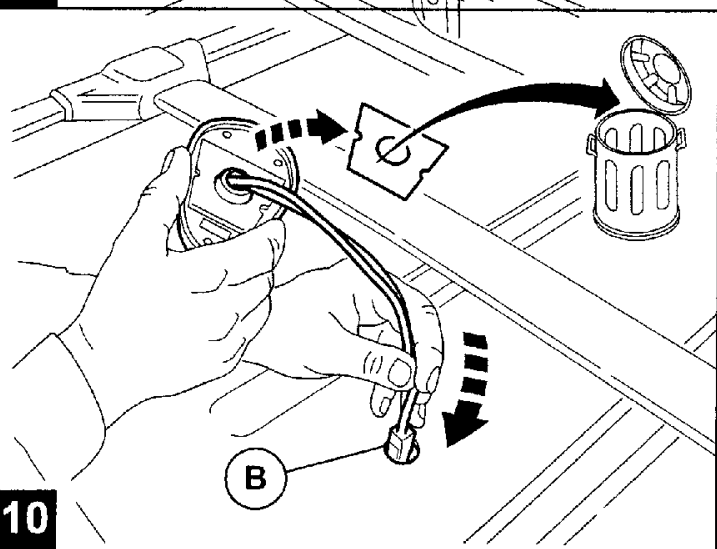

11

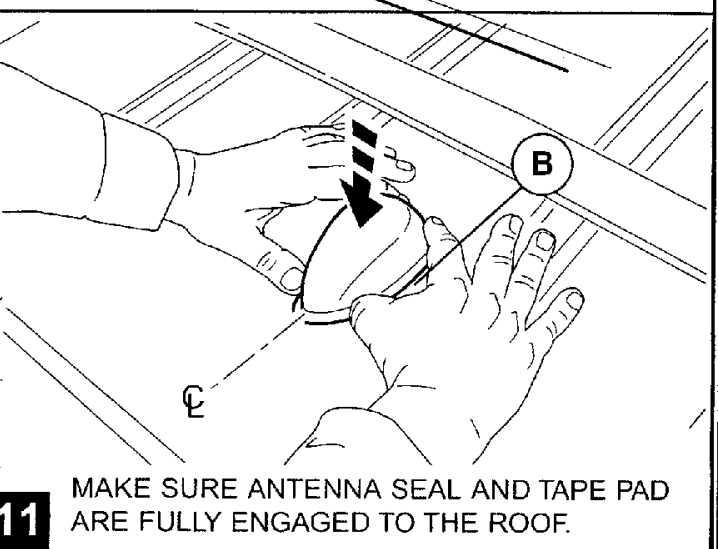

MAKE SURE ANTENNA SEAL AND TAPE PAD ARE FULLY ENGAGED TO THE ROOF.

VEHICLES EQUIPPED WITH CD CHANGER.

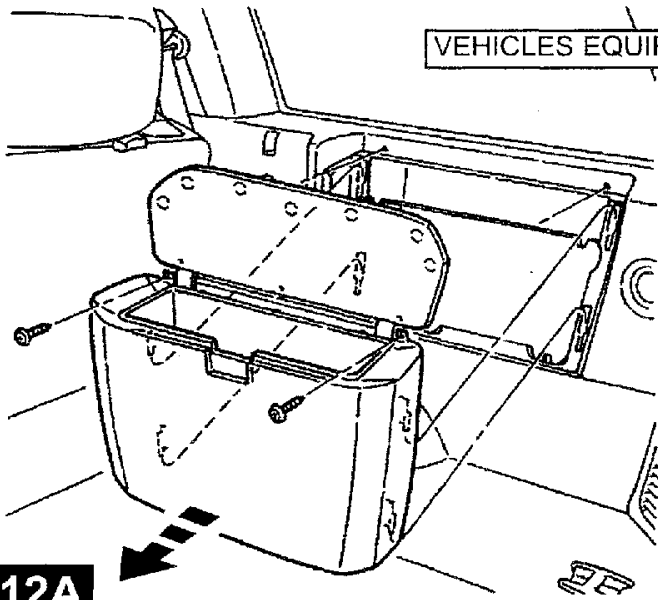

12A

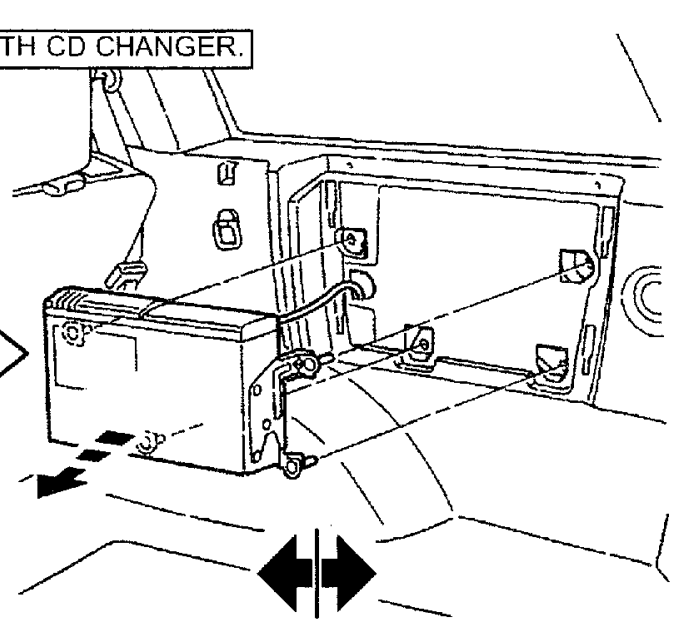

VEHICLES WITHOUT CD CHANGER.

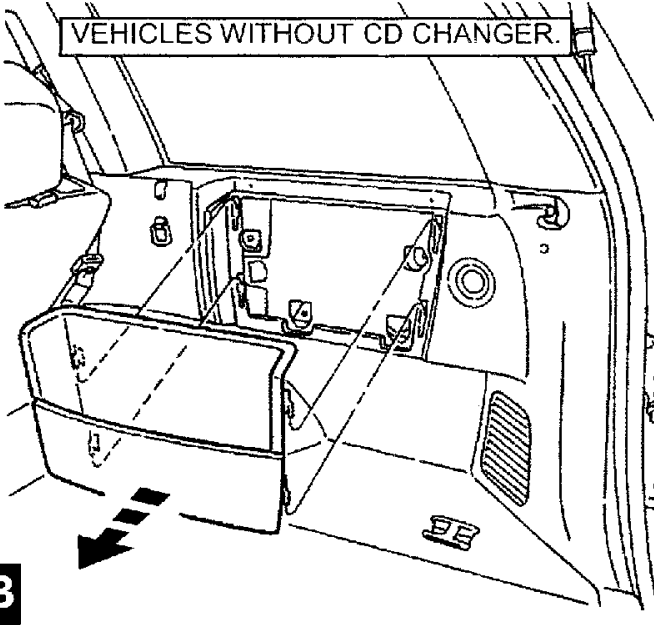

12B

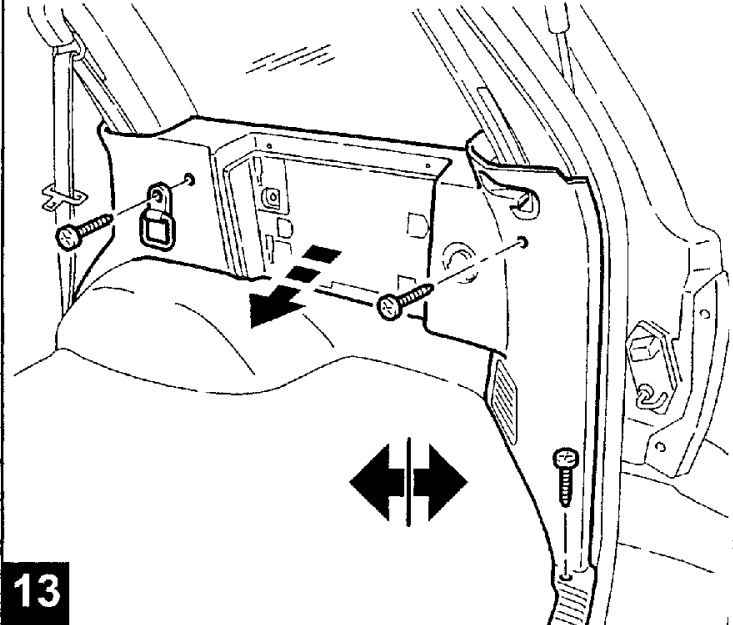

13

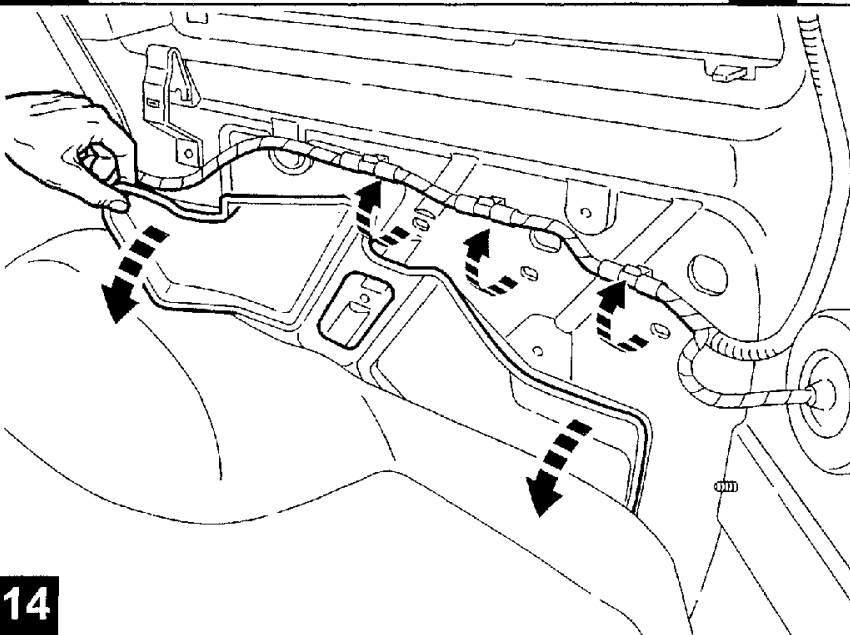

14

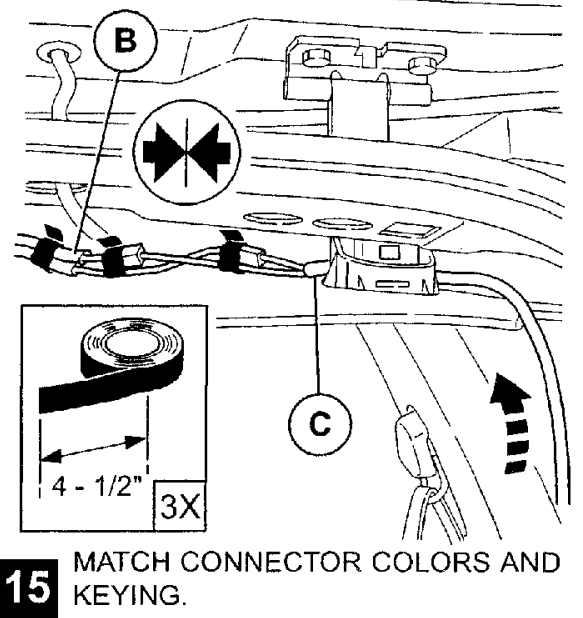

15

DO NOT BEND (MORE THAN 90°), KINK, TIE-STRAP, OR TIGHTLY COIL THE CABLE.

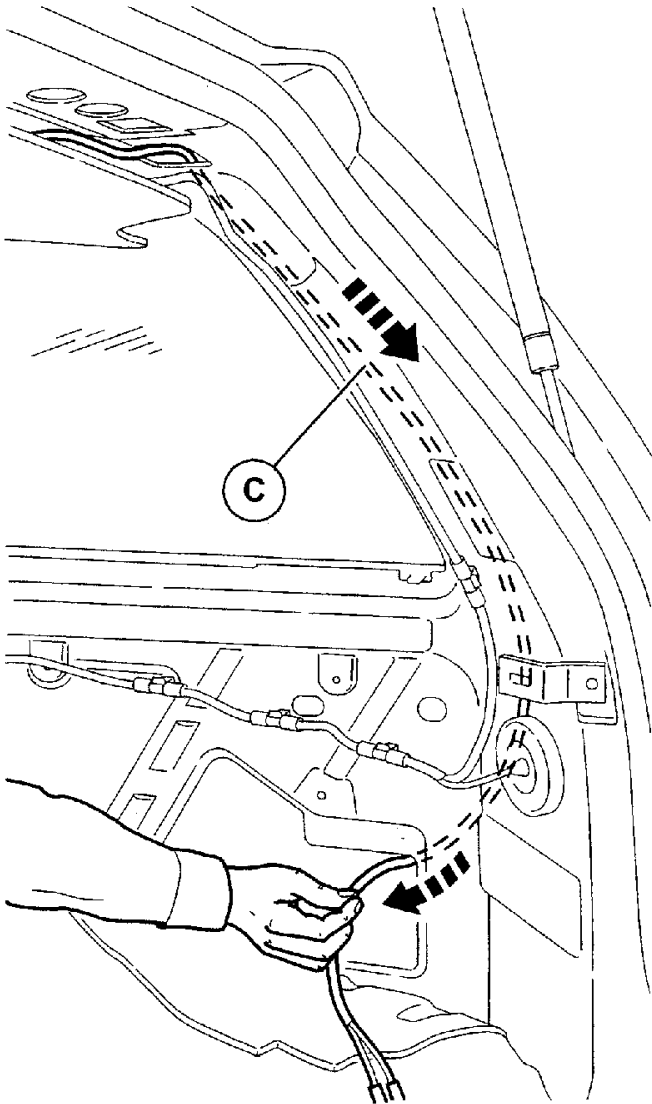

16 USE SUPPLIED CLIPS TO PROVIDE STRAIN RELIEF (4"-8" FROM CONNECTION POINTS).

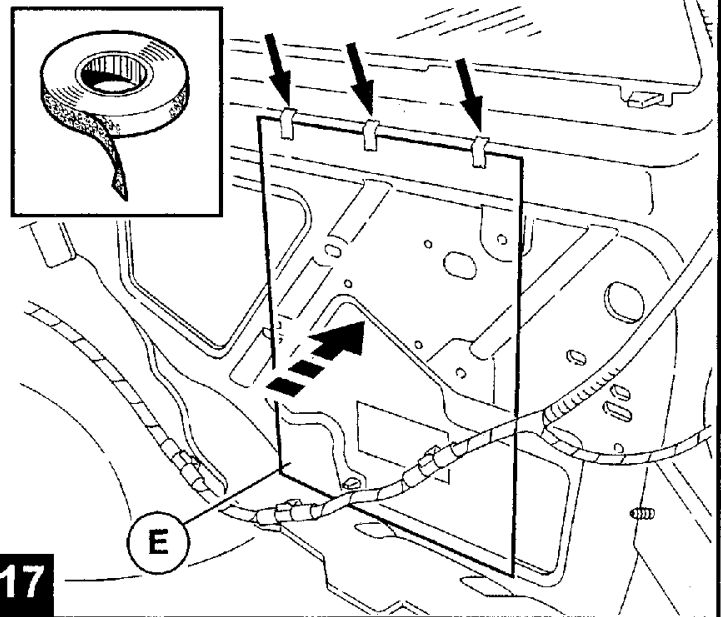

17

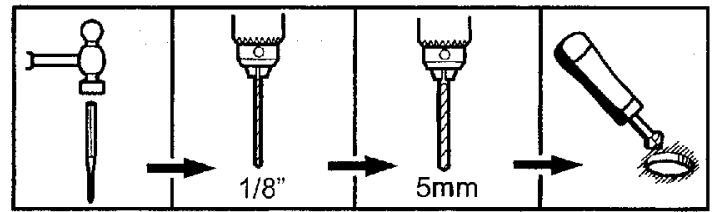

18

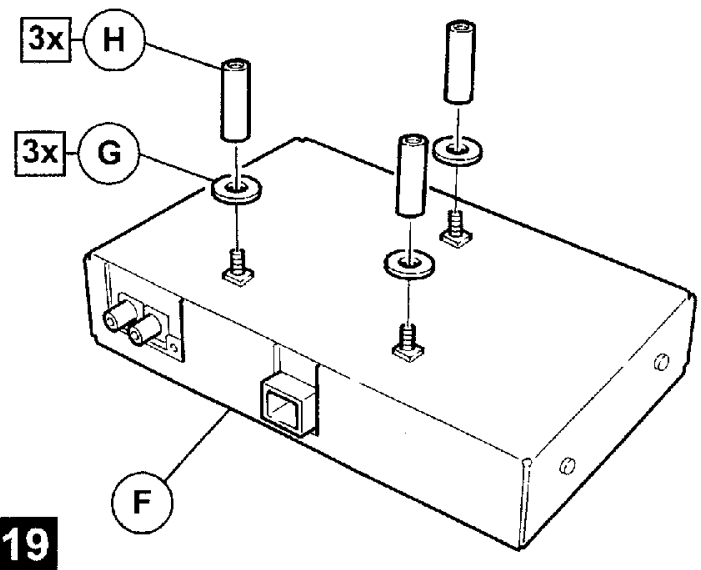
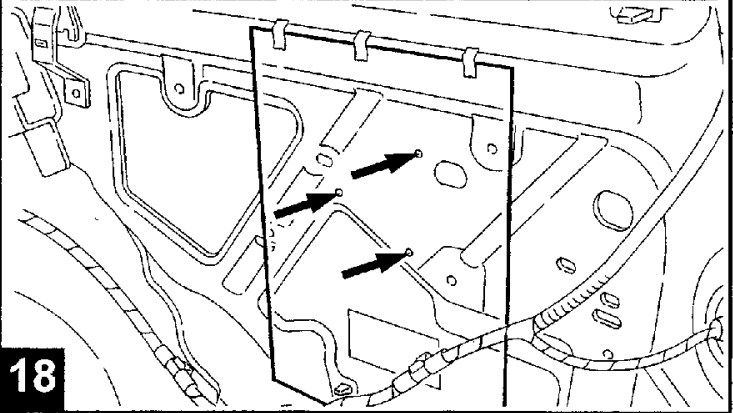

19

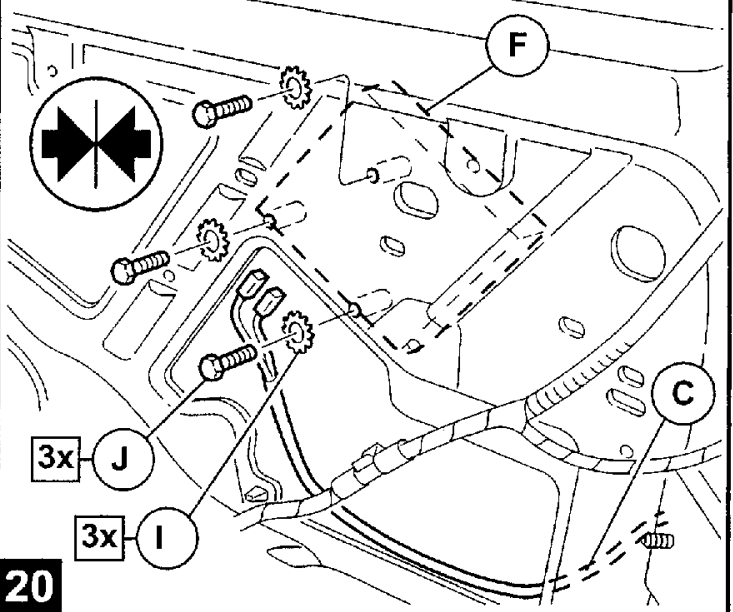

20

VEHICLES EQUIPPED WITH CD CHANGER: FOLLOW STEPS 21-31.
 VEHICLES WITHOUT CD CHANGER: SKIP TO STEP 32.

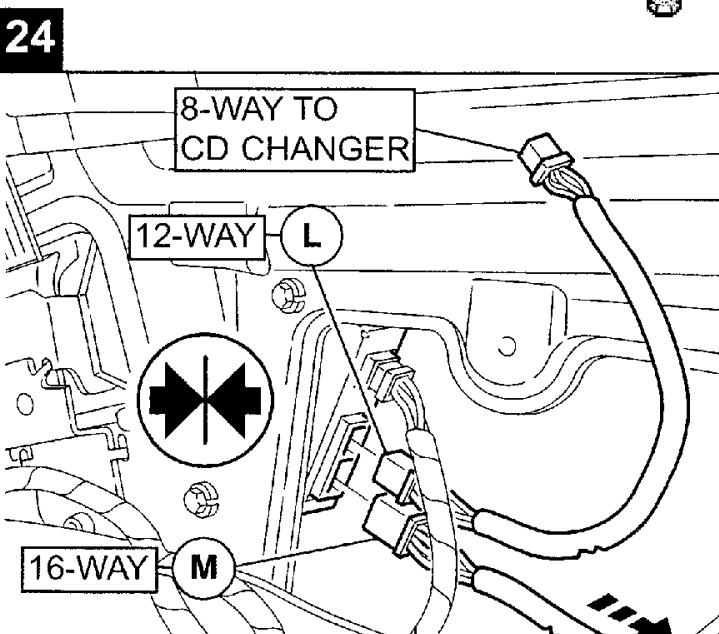
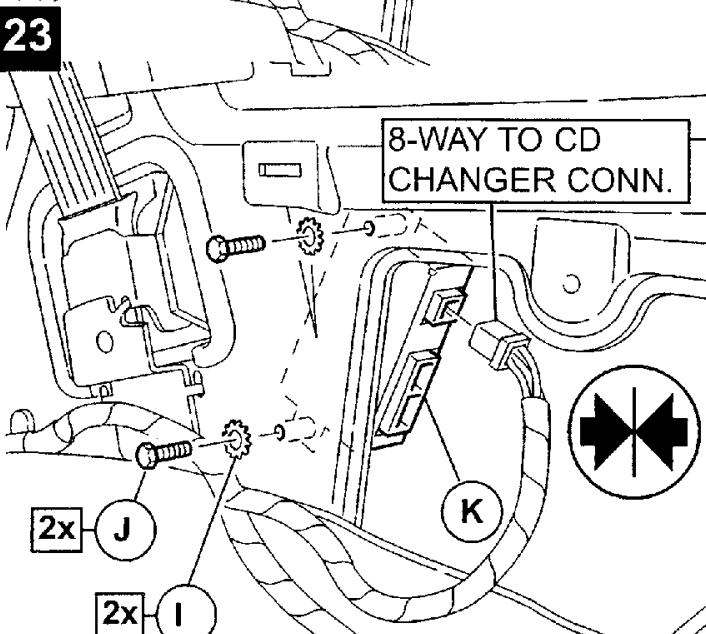
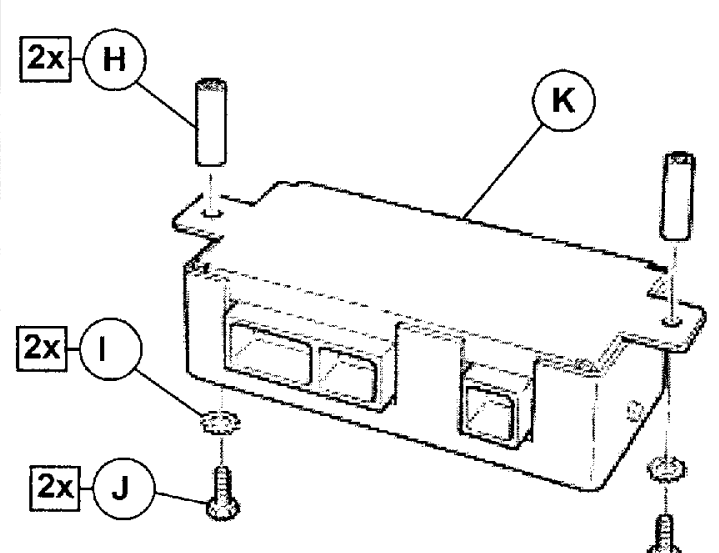
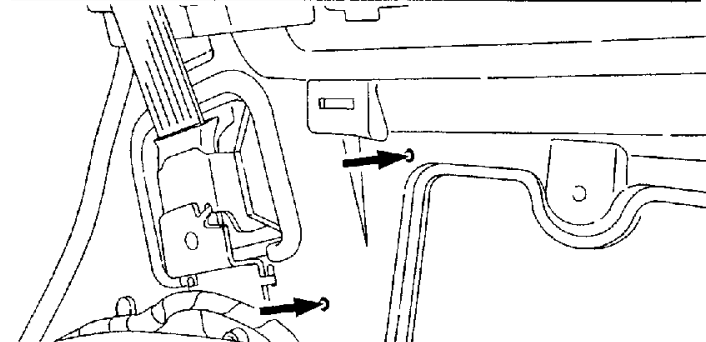
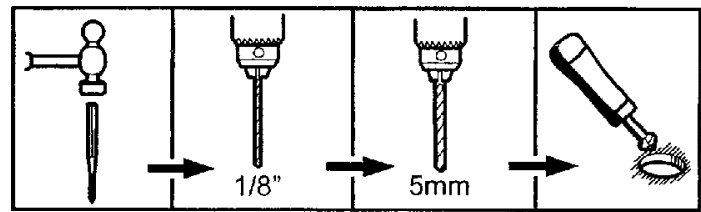
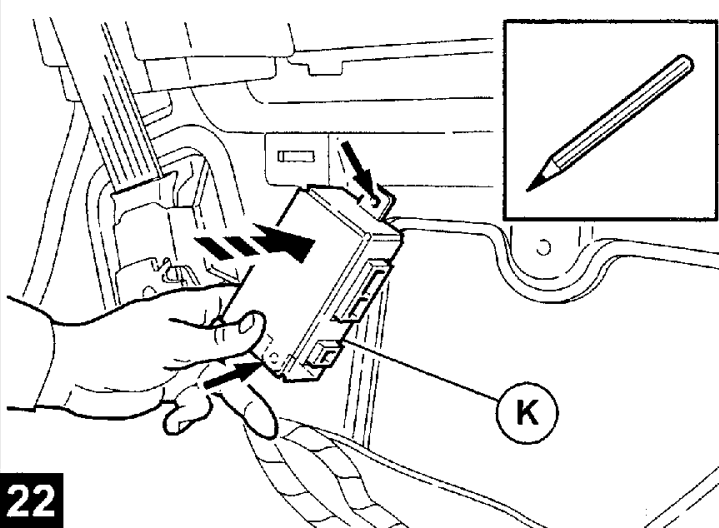
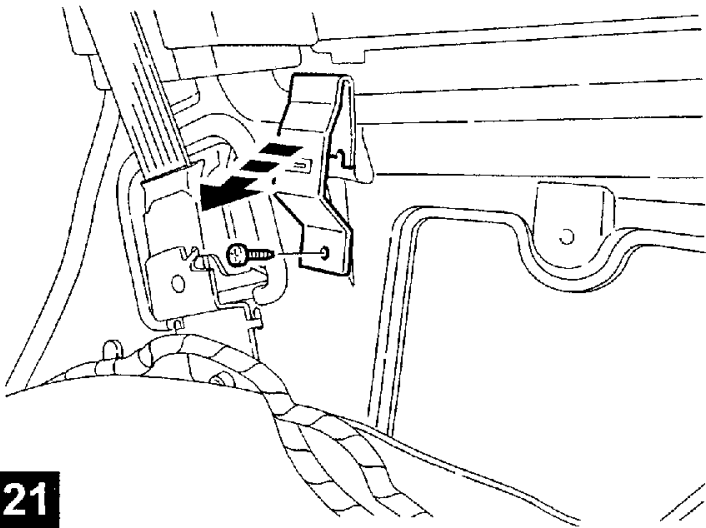

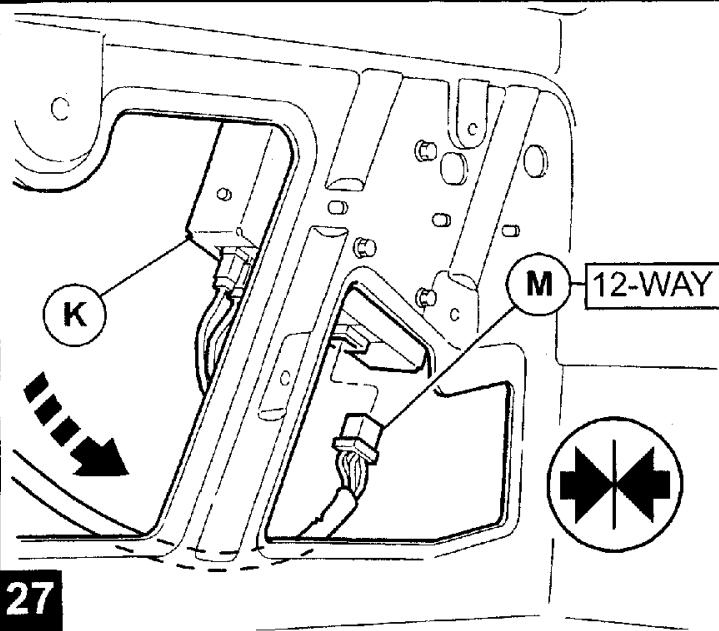

27

QUARTER PANEL SOUND DEADNER
(REMOVED IN STEP 14).

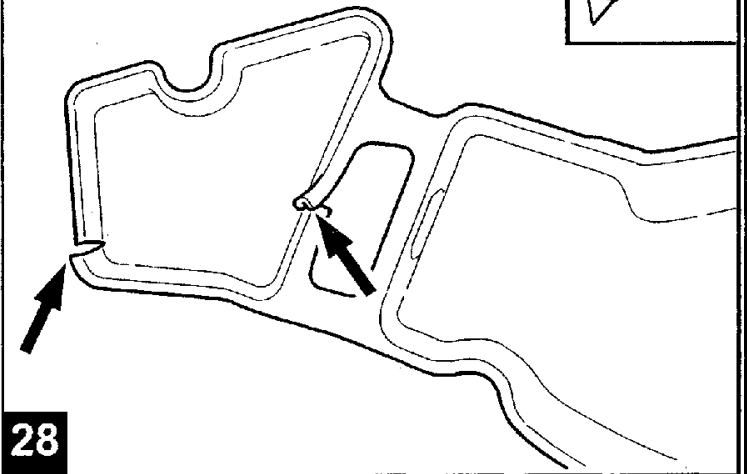
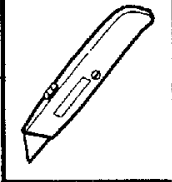

28

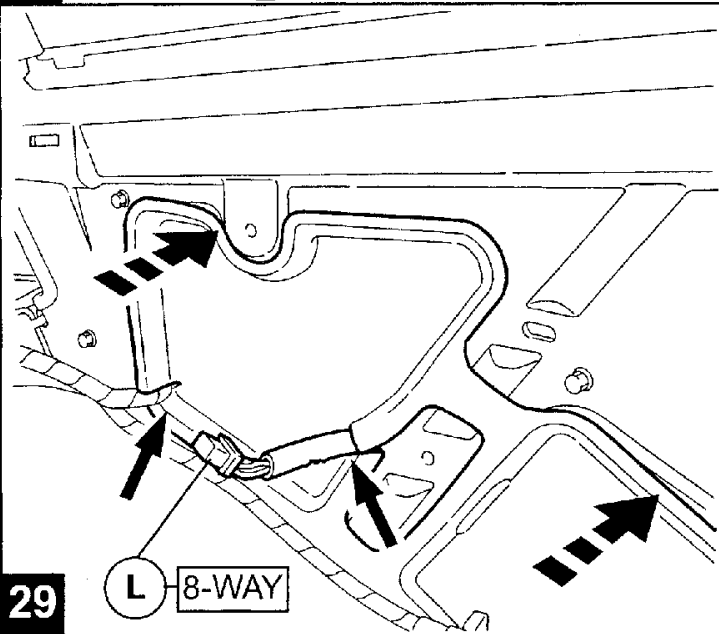

29

- RE-INSTALL RIGHT INNER QUARTER PANEL.
- PLUG 8-WAY CONNECTOR INTO CD CHANGER.
- RE-INSTALL CD CHANGER AND REAR CONSOLE.
- REFER TO OWNERS MANUAL FOR SYSTEM SET-UP.

IMPORTANT! PLEASE AFFIX ESN STICKERS TO OWNER'S MANUAL, MIRROR TAG AND ORANGE CARD. INSTALL MIRROR TAG AND ATTACH ORANGE CARD TO INVOICE (THESE ITEMS CONTAINED IN RECEIVER KIT).

30

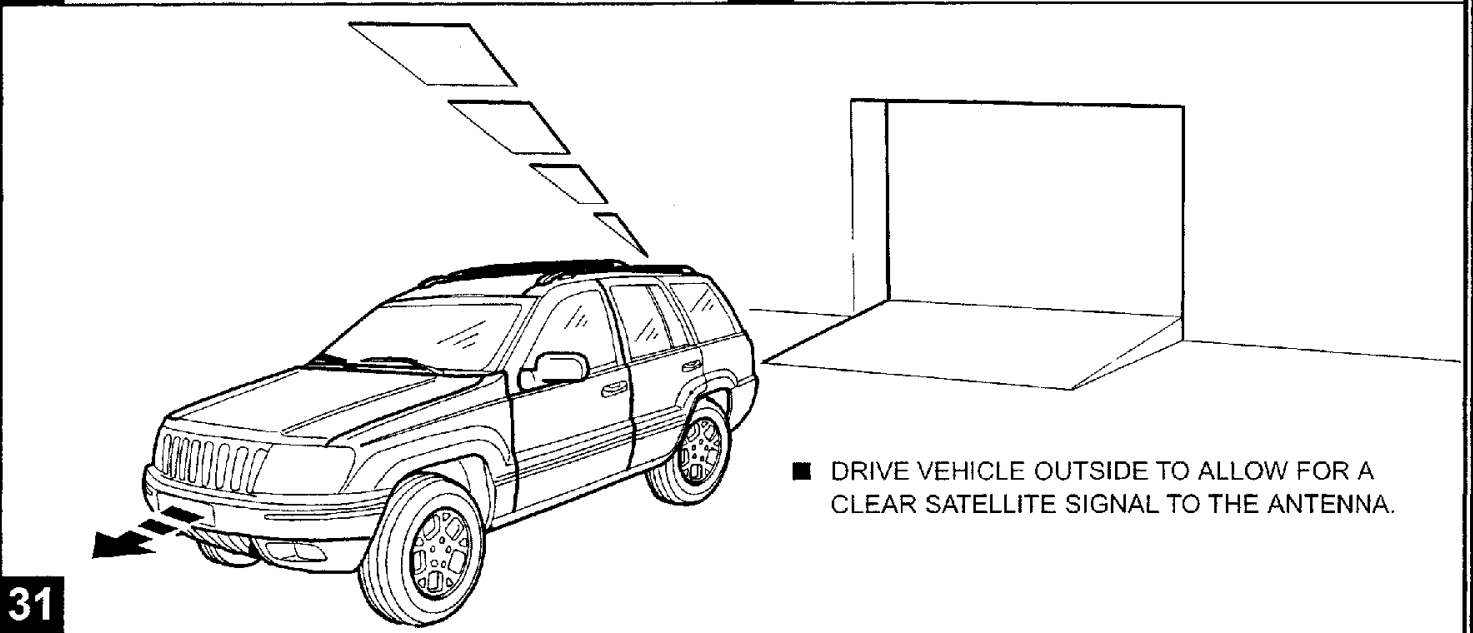

31

- DRIVE VEHICLE OUTSIDE TO ALLOW FOR A CLEAR SATELLITE SIGNAL TO THE ANTENNA.

VEHICLES WITHOUT CD CHANGER: FOLLOW STEPS 32-42

32

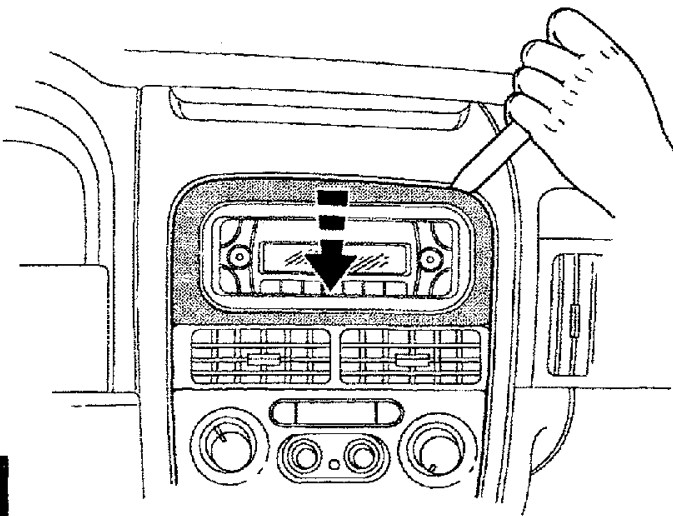

33

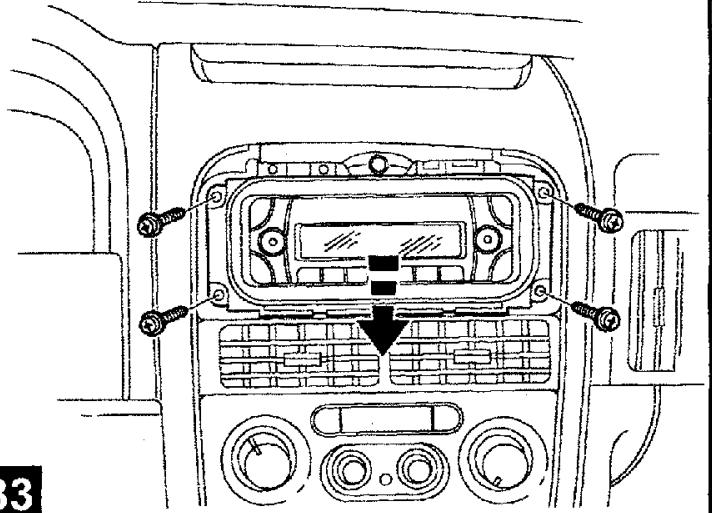

34

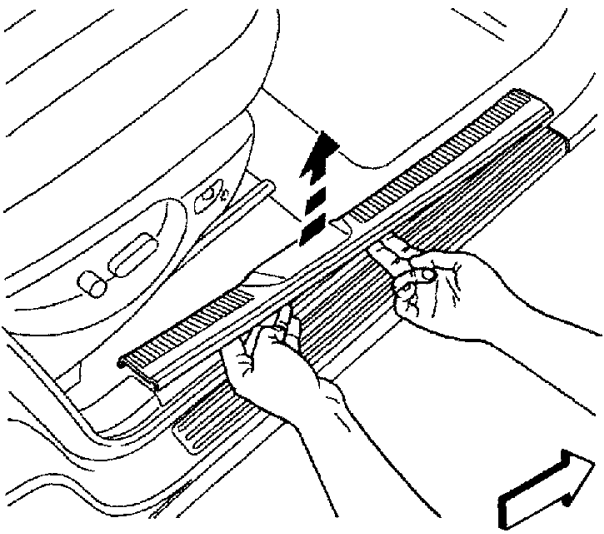

35

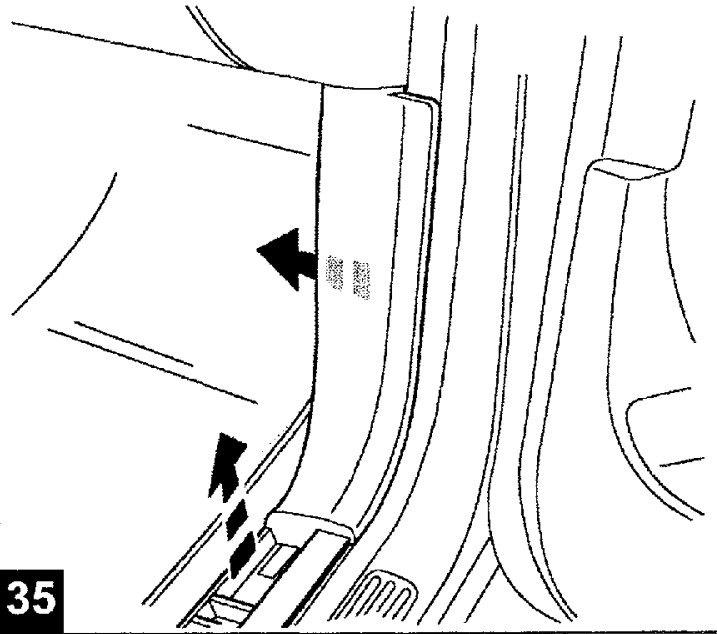

36

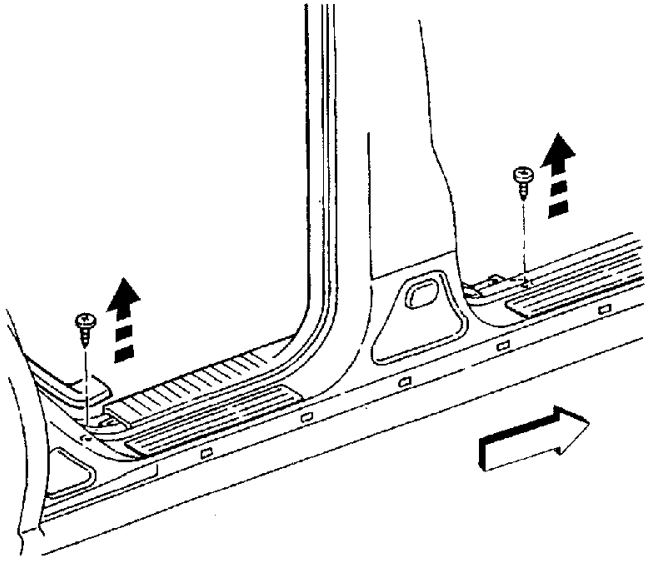

37

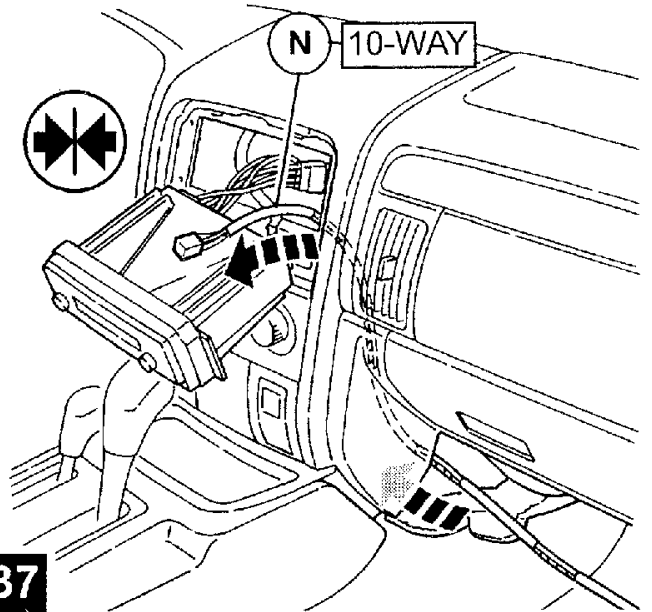

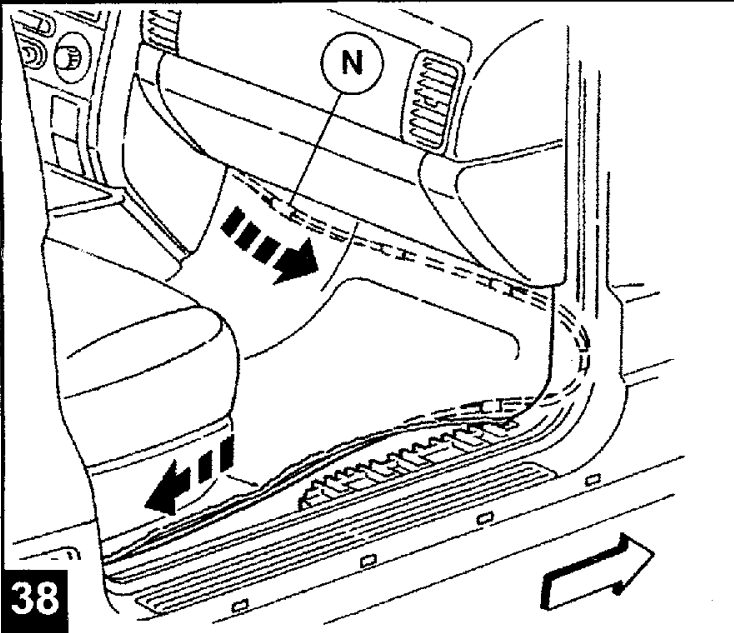

38

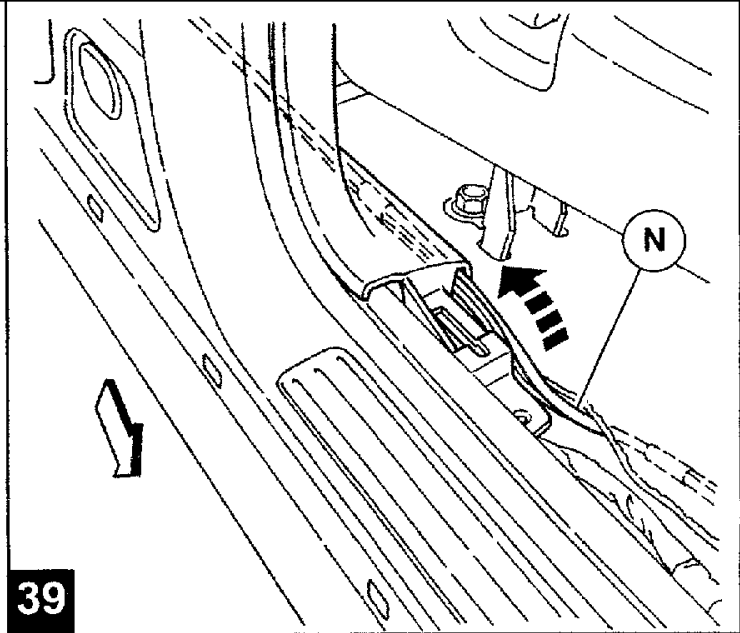

39

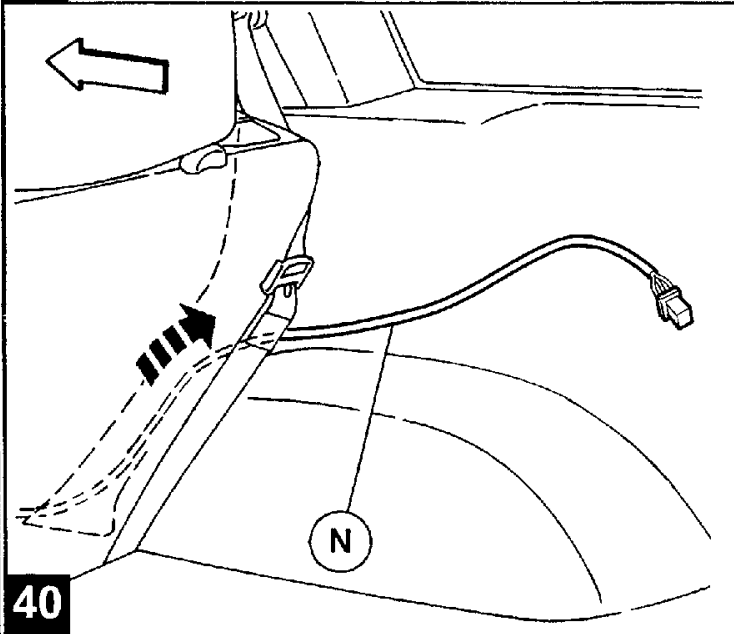

40

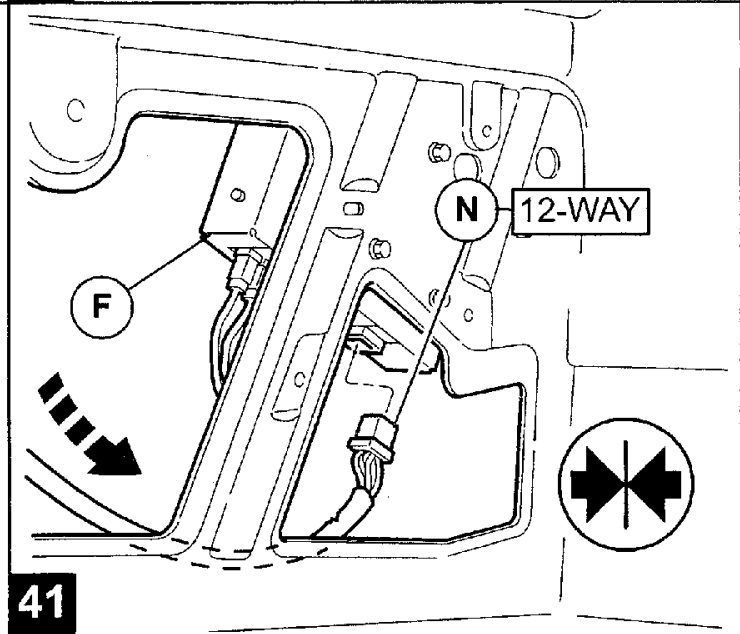

41

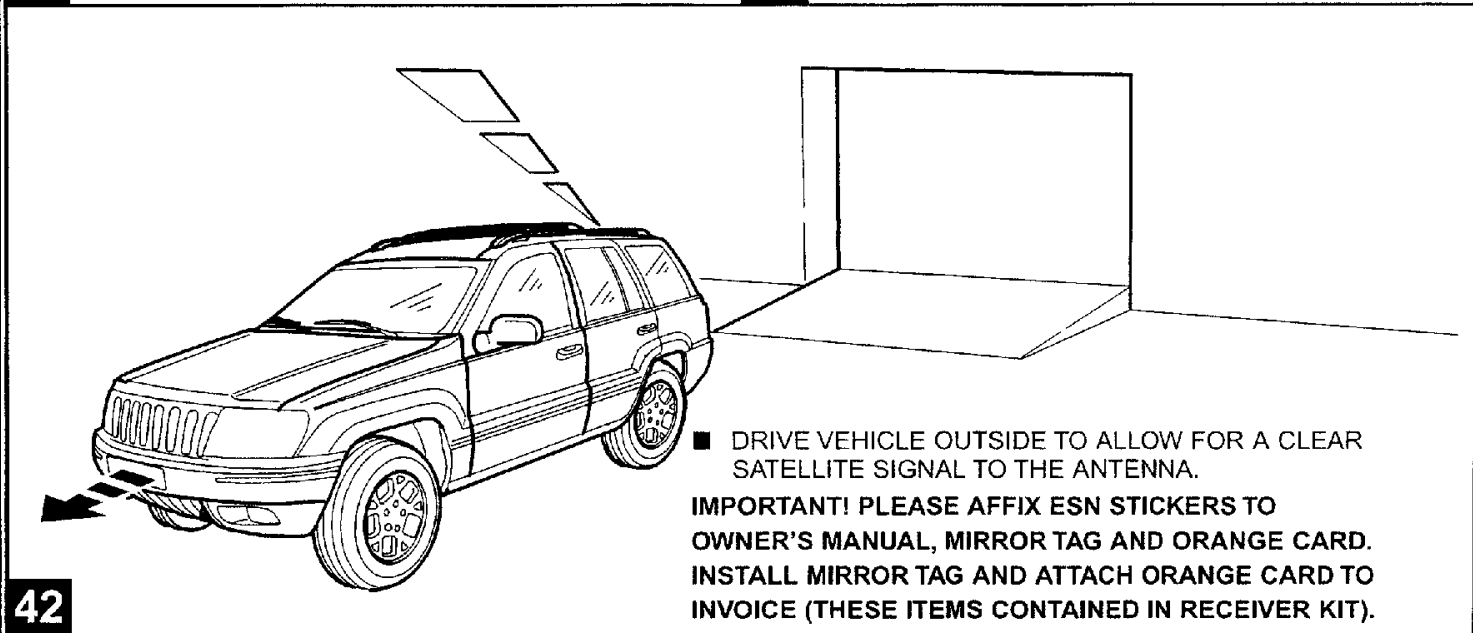

42

■ DRIVE VEHICLE OUTSIDE TO ALLOW FOR A CLEAR SATELLITE SIGNAL TO THE ANTENNA.
IMPORTANT! PLEASE AFFIX ESN STICKERS TO OWNER'S MANUAL, MIRROR TAG AND ORANGE CARD. INSTALL MIRROR TAG AND ATTACH ORANGE CARD TO INVOICE (THESE ITEMS CONTAINED IN RECEIVER KIT).